

Models HRW-CA and HRW-CAM

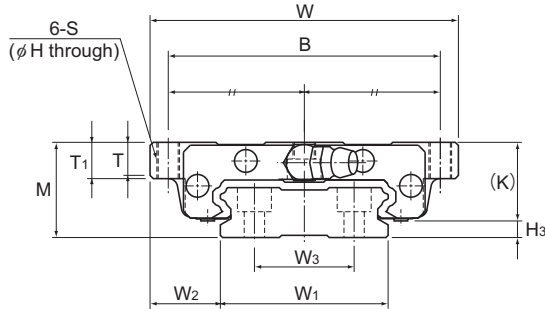

Model No.	Outer dimensions			LM block dimensions											Grease nipple	H ₃
	Height	Width	Length	B	C	H	S	L ₁	T	T ₁	K	N	E			
	M	W	L	B	C	H	S	L ₁	T	T ₁	K	N	E		H ₃	
HRW 17CA HRW 17CAM	17	60	50.8	53	26	3.3	M4	33.6	5.5	6	14.5	4	2	PB107	2.5	
HRW 21CA HRW 21CAM	21	68	58.8	60	29	4.4	M5	40	7.3	8	18	4.5	12	B-M6F	3	
HRW 27CA HRW 27CAM	27	80	72.8	70	40	5.3	M6	51.8	9.5	10	24	6	12	B-M6F	3	
HRW 35CA HRW 35CAM	35	120	106.6	107	60	6.8	M8	77.6	13	14	31	8	12	B-M6F	4	
HRW 50CA	50	162	140.5	144	80	8.6	M10	103.5	16.5	18	46.6	14	16	B-PT1/8	3.4	
HRW 60CA	60	200	158.9	180	80	10.5	M12	117.5	23.5	25	53.5	15	16	B-PT1/8	6.5	

Note) Symbol M indicates that stainless steel is used in the LM block, LM rail and balls. Those models marked with this symbol are therefore highly resistant to corrosion and environment.

Model number coding

HRW35 CA 2 UU C1 M +1000L P T M

Model number

Type of LM block

Contamination protection accessory symbol (*1)

Stainless steel LM block

LM rail length (in mm)

Symbol for LM rail jointed use

Stainless steel LM rail

No. of LM blocks used on the same rail

Radial clearance symbol (*2)

Normal (No symbol)

Light preload (C1)

Medium preload (C0)

Accuracy symbol (*3)

Normal grade (No Symbol)/High accuracy grade (H)

Precision grade (P)/Super precision grade (SP)

Ultra precision grade (UP)

(*1) See contamination protection accessory on **A1-492**. (*2) See **A1-71**. (*3) See **A1-76**.

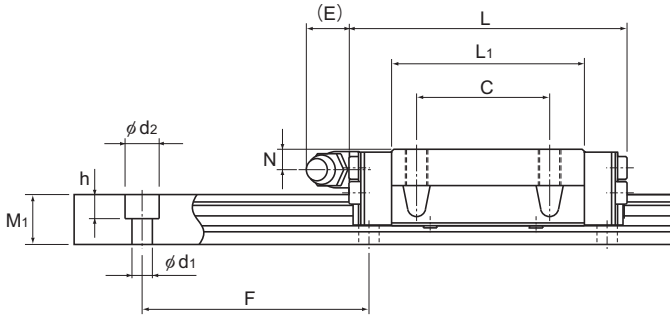

Unit: mm

	LM rail dimensions							Basic load rating		Static permissible moment kN-m*					Mass	
	Width		Height	Pitch	Length*	C	C ₀	M _A		M _B		M _C	LM block	LM rail		
	W ₁	W ₂						1 block	Double blocks	1 block	Double blocks	1 block				
	±0.05		M ₁	F	d ₁ × d ₂ × h	Max	kN	kN				kg	kg/m			
	33	13.5	18	9	40	4.5 × 7.5 × 5.3	1900 (800)	4.31	8.14	0.0417	0.244	0.0417	0.244	0.128	0.15	2.1
	37	15.5	22	11	50	4.5 × 7.5 × 5.3	3000 (1000)	6.18	11.5	0.0701	0.398	0.0701	0.398	0.194	0.25	2.9
	42	19	24	15	60	4.5 × 7.5 × 5.3	3000 (1200)	11.5	20.4	0.156	0.874	0.156	0.874	0.398	0.5	4.3
	69	25.5	40	19	80	7 × 11 × 9	3000	27.2	45.9	0.529	2.89	0.529	2.89	1.49	1.4	9.9
	90	36	60	24	80	9 × 14 × 12	3000	50.2	81.5	1.25	6.74	1.25	6.74	3.46	4	14.6
	120	40	80	31	105	11 × 17.5 × 14	3000	63.8	102	1.76	12.3	1.76	12.3	5.76	5.7	27.8

Note) The maximum length under "Length*" indicates the standard maximum length of an LM rail. (See **A1-246**.)

Static permissible moment*: 1 block: static permissible moment value with 1 LM block

Double blocks: static permissible moment value with 2 blocks closely contacting with each other